

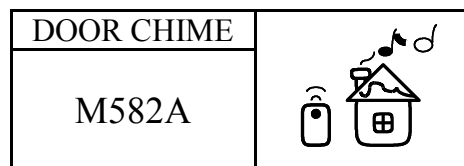

DING-DONG
DOOR BELL

單音門鈴 IC



FEATURES 功能敘述

- Ding-Dong 2 times.
- OSH or VDD Control.
- Separate LED and BUZZER driver.

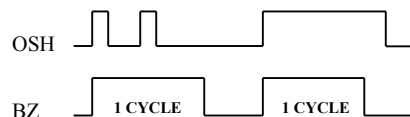

APPLICATION 產品應用

- Door Bell, Toys.

ELECTRICAL CHARACTERISTICS 電氣規格

(@V_{DD}=3V unless otherwise specified)

Characteristics	Sym.	Min.	Typ.	Max.	Unit	REMARKS
工作電壓 Operating Voltage	V _{DD}	—	3	4.5	V	
工作電流 Operating Current	I _{OP}	—	0.1	0.5	mA	No load
靜態電流 Quiescent Current	I _{SB}	—	1	5	μA	
推動電流 BZ Driving Current	I _O	1	—	—	mA	@V _{DS} =1V
推動電流 LO Driving Current	I _{OL}	6	—	—	mA	@V _{DS} =1.2V
振盪頻率 Oscillator Frequency	F _{OSC}	—	100	—	KHz	±30% TOL.
工作溫度 Operating Temperature	Temp.	0	25	60	°C	

APPLICATION DIAGRAM 參考電路圖

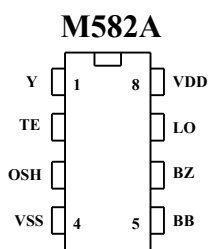
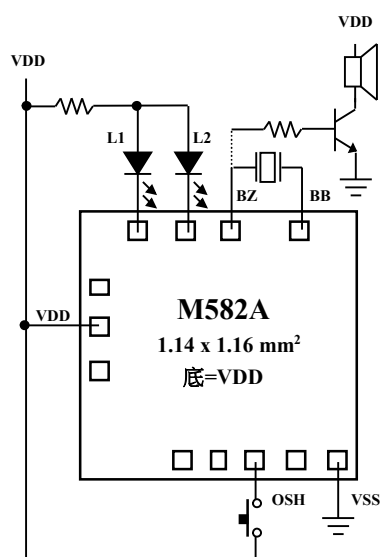

TO93-4L (Suffix-F)

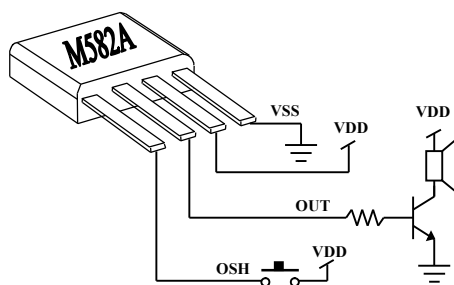

TO92-3L

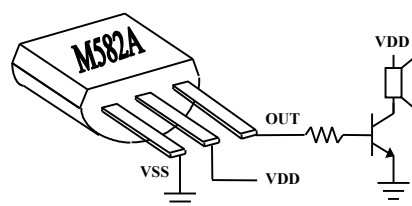

*All specs and applications shown above subject to change without prior notice.

(以上電路及規格僅供參考,本公司得逕行修正)



DING-DONG
DOOR BELL

單音門鈴 IC

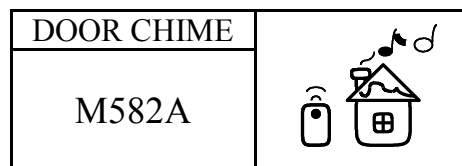

PAD ASSIGNMENT & POSITION

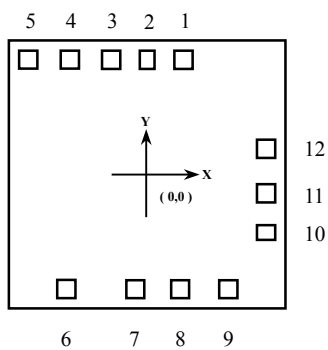

UNIT : um

No.	NAME	X	Y
1	X	201	454
2	TO	47	456
3	OSH	-103	454
4	LH	-275	454
5	VSS	-447	454
6	BB	-382	-408
7	BZ	-95	-408
8	L2	91	-404
9	L1	290	-404
10	TE	443	-258
11	VDD	446	-93
12	Y	446	88

* CHIP SIZE ~ 1.14 x 1.16 mm²

* IC substrate should be connected to VDD in PCB (PCB 上 IC 必須接 VDD)