

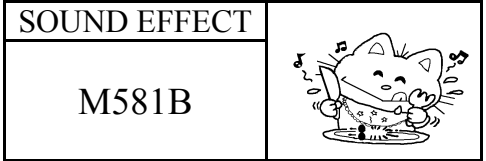

DING-DONG
DOOR BELL

單音門鈴 IC



FEATURES 功能敘述

- K1 : Ding-Dong 2 times (~2.8 second)
- K2 : Ding-Dong 1 times (~1 second).
- K3 : Ding-Dong 1 times (~1.2 second).
- MODE : OSH(one-shot) , Non-retrigger.
- Separate LED and Buzzer driver.

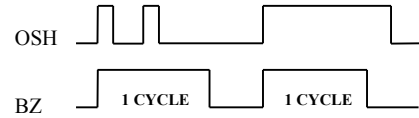

APPLICATION 產品應用

- Door Bell , Toys.

ELECTRICAL CHARACTERISTICS 電氣規格

(@V_{DD}=3V unless otherwise specified)

Characteristics	Sym.	Min.	Typ.	Max.	Unit	REMARKS
工作電壓 Operating Voltage	V _{DD}	—	3	4.5	V	
工作電流 Operating Current	I _{OP}	—	0.1	0.5	mA	No load
靜態電流 Quiescent Current	I _{SB}	—	1	5	μA	
推動電流 BZ Driving Current	I _O	1	—	—	mA	@V _{DS} =1V
振盪頻率 Oscillator Frequency	F _{OSC}	—	4	—	MHz	internal RC oscillator
工作溫度 Operating Temperature	Temp.	0	25	60	°C	

APPLICATION DIAGRAM 參考電路圖

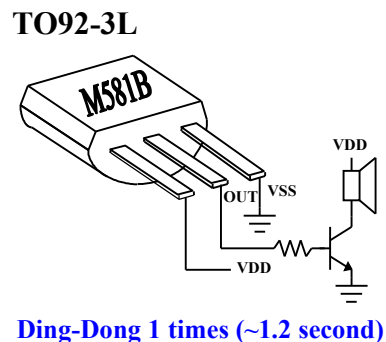
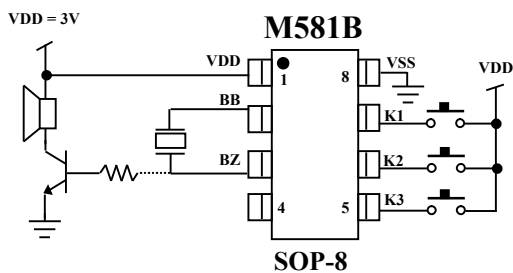

*All specs and applications shown above subject to change without prior notice.

(以上電路及規格僅供參考,本公司得逕行修正)



DING-DONG
DOOR BELL

單音門鈴 IC

SOUND EFFECT

M581B



PACKAGE OUTLINE

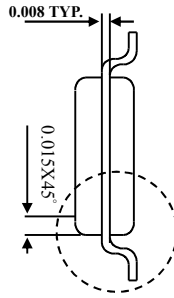
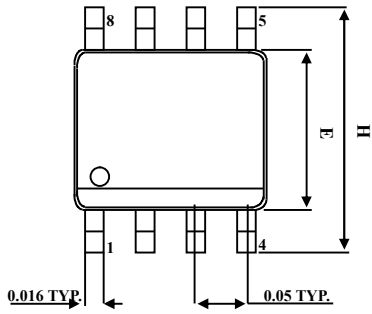

SYMBOLS	MIN	MAX
A	0.053	0.069
A1	0.004	0.010
A2		0.059
D	0.189	0.196
E	0.150	0.157
H	0.228	0.244
L	0.016	0.050
θ	0	8

Unit: INCH

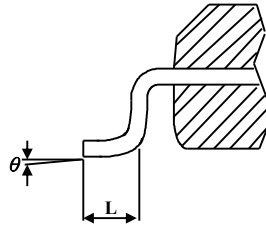
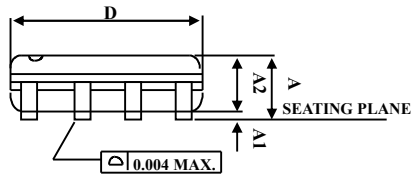

SOP-8