

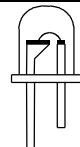

HIGH VOLTAGE
RGB LED IC

16 色 LED IC

LED FLASH	
M1361	

FEATURES 功能叙述

- Operating voltage 3 ~18 volt.
- Totally 16 mix color.
- Adjustable flash time via external R,C
- 8-pin DIP/ SOP package.

APPLICATION 产品应用

- Atomizer, color LED for car, garden light etc..

ELECTRICAL CHARACTERISTICS 电气规格

(@V_{DD}=12V unless otherwise specified)

Characteristics	Sym.	Min.	Typ.	Max.	Unit	REMARKS
工作电压 Operating Voltage	V _{DD}	3	12	18	V	
工作电流 Operating Current	I _{OP}	—	0.5	—	mA	No load
推动电流 Driving Source Current	I _{OH}	—	30	60	mA	@V _{SD} = 1.2 V
振荡频率 Oscillator Frequency	F _{OSC}	—	50	—	Hz	R,C external one pin oscillator
工作温度 Operating Temperature	Temp.	0	25	60	C°	

APPLICATION DIAGRAM 参考电路图

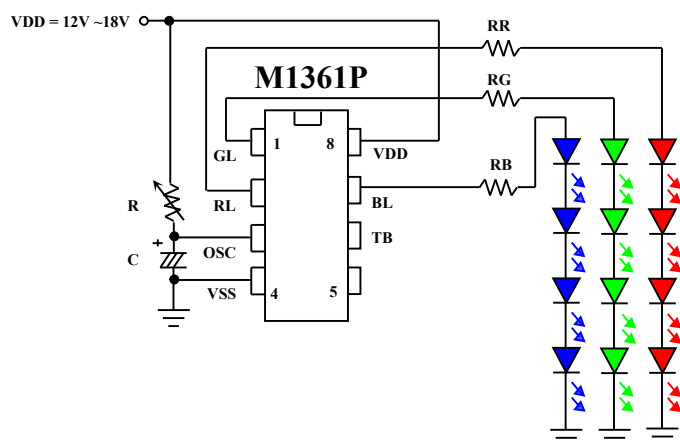









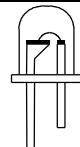







@V _{DD} =12V		
R (KΩ)	C (μ f)	TIME (Sec.)
270	0.1	0.5
470	0.1	1
750	0.1	1.5
75	1	2
100	1	2.5
200	1	5
270	1	7
430	1	10



HIGH VOLTAGE
RGB LED IC

16 色 LED IC

LED FLASH	
M1361	

LED	1	2	3	4	5	6	7	8	9	10	11	12	13	14	15	16
RL	—	—	—	—	—	1	1/2	1	1	1/2	1	1	1	1	1/4	1
GL	1	1	1	1/4	—	—	—	—	1/2	1	1	1/4	1/4	1/4	1	1
BL	1/2	—	1	1	1	—	1	1	—	—	—	—	1/4	1	1	1
颜色																
名称	青草绿 Spring Green	绿 Green	靛 Indigo	宝蓝 Sapphire Blue	蓝 Blue	红 Red	紫罗兰 Violet	桃红 Dark Pink	土黄 Yellowish Brown	黄绿 Chartreuse	黄 Yellow	橘红 Orange Red	蕃茄红 Tomato	青紫 Blue Violet	青 Cyan	白 White

* 注：R,G,B LED 混合后的颜色及名称会因选用的 LED 发光波长及照度不同而有所差异，以上仅供参考。

* All specs and applications shown above subject to change without prior notice.
(以上电路及规格仅供参考,本公司得径行修正)