

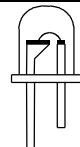

HIGH VOLTAGE  
RGB LED IC

16 色 LED IC

LED FLASH	
M1361	

**FEATURES 功能敘述**

- Operating voltage 3 ~18 volt.
- Totally 16 mix color.
- Adjustable flash time via external R,C
- 8-pin DIP/ SOP package.

**APPLICATION 產品應用**

- Atomizer, color LED for car, garden light etc..

**ELECTRICAL CHARACTERISTICS 電氣規格**

( @V<sub>DD</sub>=12V unless otherwise specified )

Characteristics	Sym.	Min.	Typ.	Max.	Unit	REMARKS
工作電壓 Operating Voltage	V <sub>DD</sub>	3	12	18	V	
工作電流 Operating Current	I <sub>OP</sub>	—	0.5	—	mA	No load
推動電流 Driving Source Current	I <sub>OH</sub>	—	30	60	mA	@V <sub>SD</sub> = 1.2 V
振盪頻率 Oscillator Frequency	F <sub>OSC</sub>	—	50	—	Hz	R,C external one pin oscillator
工作溫度 Operating Temperature	Temp.	0	25	60	°C	

**APPLICATION DIAGRAM 參考電路圖**

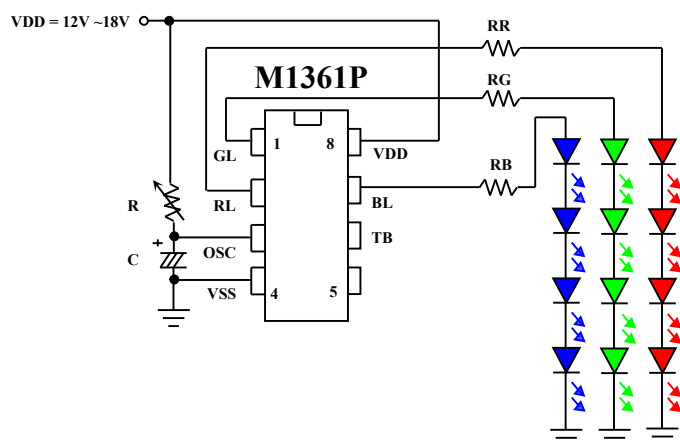







@V <sub>DD</sub> =12V		
R (KΩ)	C (μf)	TIME (Sec.)
270	0.1	0.5
470	0.1	1
750	0.1	1.5
75	1	2
100	1	2.5
200	1	5
270	1	7
430	1	10

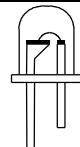

HIGH VOLTAGE  
RGB LED IC

16 色 LED IC

LED FLASH	
M1361	

LED	1	2	3	4	5	6	7	8	9	10	11	12	13	14	15	16
RL	—	—	—	—	—	1	1/2	1	1	1/2	1	1	1	1	1/4	1
GL	1	1	1	1/4	—	—	—	—	1/2	1	1	1/4	1/4	1/4	1	1
BL	1/2	—	1	1	1	—	1	1	—	—	—	—	1/4	1	1	1
顏色																
名稱	青草綠 Spring Green	綠 Green	靛 Indigo	寶藍 Sapphire Blue	藍 Blue	紅 Red	紫羅蘭 Violet	桃紅 Dark Pink	土黃 Yellowish Brown	黃綠 Chartreuse	黃 Yellow	橘紅 Orange Red	蕃茄紅 Tomato	青紫 Blue Violet	青 Cyan	白 White

\* 註：R,G,B LED 混合後的顏色及名稱會因選用的 LED 發光波長及照度不同而有所差異，以上僅供參考。

\* All specs and applications shown above subject to change without prior notice.  
( 以上電路及規格僅供參考,本公司得逕行修正 )