

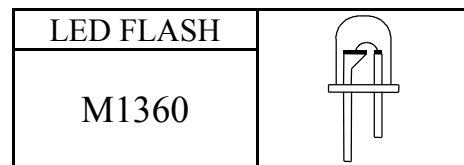

HIGH VOLTAGE
SYNC RGB LED IC

同步 16 色 LED IC



FEATURES 功能敘述

- Operating voltage 3 ~ 18 volt.
- Power-on while automatic synchronous an LEDS of the same color.
- Totally 16 mix colors.
- SP : 3 speed select pin.
- 8-pin DIP/ SOP package.

SP	TIME (Sec.)
接 A (VDD)	5.12
接 B	2.56
接 C (VSS)	1.28

APPLICATION 產品應用

- LED color mixer lamp , atomizer, garden light etc..

ELECTRICAL CHARACTERISTICS 電氣規格

(@V_{DD}=12V unless otherwise specified)

Characteristics	Sym.	Min.	Typ.	Max.	Unit	REMARKS
工作電壓 Operating Voltage	V _{DD}	3	12	18	V	
工作電流 Operating Current	I _{OP}	—	0.5	—	mA	No load
推動電流 Driving Source Current	I _{OH}	—	30	60	mA	@V _{SD} = 1.2 V
振盪頻率 Oscillator Frequency	F _{OSC}	—	50	—	Hz	AC Line Frequency
工作溫度 Operating Temperature	Temp.	0	25	60	°C	

APPLICATION DIAGRAM 參考電路圖

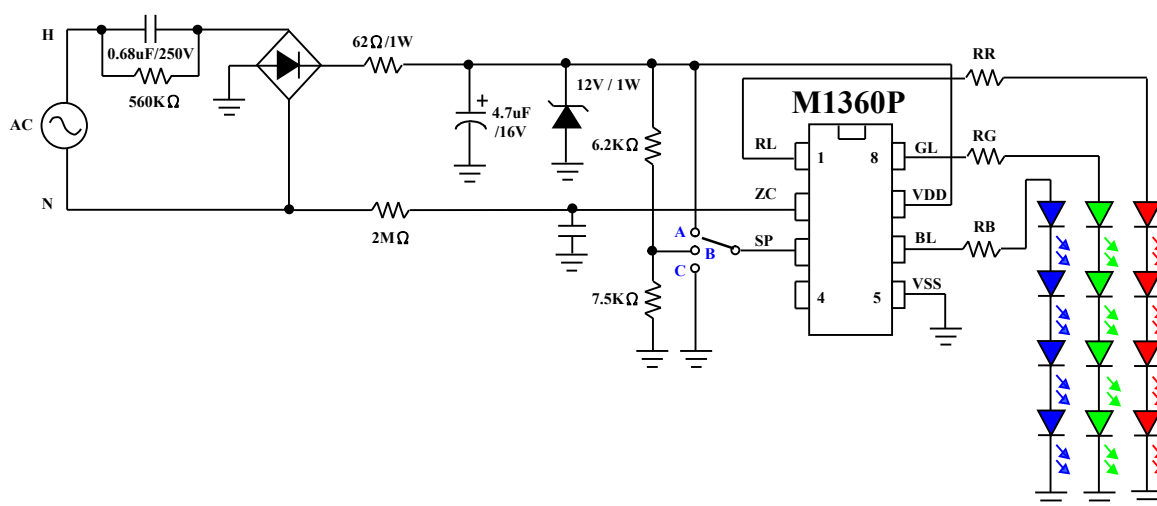









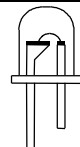







* 註：AC 同步時，斷電再上電需間隔 5 Sec。



HIGH VOLTAGE
SYNC RGB LED IC

同步 16 色 LED IC

LED FLASH	
M1360	

LED	1	2	3	4	5	6	7	8	9	10	11	12	13	14	15	16
RL	—	—	—	—	—	1	1/2	1	1	1/2	1	1	1	1	1/4	1
GL	1	1	1	1/4	—	—	—	—	1/2	1	1	1/4	1/4	1/4	1	1
BL	1/2	—	1	1	1	—	1	1	—	—	—	—	1/4	1	1	1
顏色																
名稱	青草綠 Spring Green	綠 Green	靛 Indigo	寶藍 Sapphire Blue	藍 Blue	紅 Red	紫羅蘭 Violet	桃紅 Dark Pink	土黃 Yellowish Brown	黃綠 Chart- reuse	黃 Yellow	橘紅 Orange Red	蕃茄紅 Tomato	青紫 Blue Violet	青 Cyan	白 White

* 註：R,G,B LED 混合後的顏色及名稱會因選用的 LED 發光波長及照度不同而有所差異，以上僅供參考。

* All specs and applications shown above subject to change without prior notice.
(以上電路及規格僅供參考,本公司得逕行修正)