

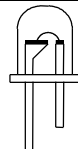

VDD CONTROL 64 PATTERN
VISION PERSISTENCE

電源控制
閃爍圖案 IC

LED FLASH	
M1173A / -1	

FEATURES 功能敘述

- VDD control.
- Level Hold Mode.
- 5 LED 64 patterns.
- Built-in oscillator.

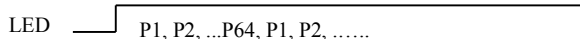

APPLICATION 產品應用

- Blinking LED, Functions indicator, Xmas decoration.

ELECTRICAL CHARACTERISTICS 電氣規格

(@V_{DD}=3V unless otherwise specified)

Characteristics	Sym.	Min.	Typ.	Max.	Unit	REMARKS
工作電壓 Operating Voltage	V _{DD}	2	3	5	V	
工作電流 Operating Current	I _{OP}	96	120	144	μ A	
推動電流 Driving Current	I _{OL}	4	—	—	mA	@V _{DS} =1.2V
振盪頻率 Oscillator Frequency	F _{osc}	—	210	—	KHz	±30% TOL.

APPLICATION DIAGRAM 參考電路圖

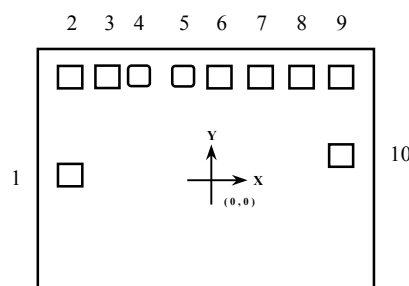
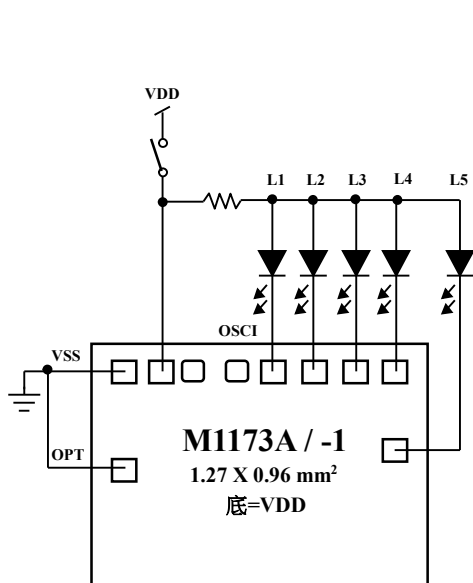

UNIT : um

No.	NAME	X	Y
1	OPT	-497.75	-24.5
2	VSS	-497.75	343.6
3	VDD	-362.75	343.6
4	TPB	-240.25	343.6
5	OSCI	-71.25	343.6
6	L1	56.25	343.6
7	L2	206	343.6
8	L3	348.45	343.6
9	L4	498.2	343.6
10	L5	498.2	45.75

* CHIP SIZE ~ 1.27 x 0.96 mm²

* IC substrate should be connected to VDD in PCB (PCB 上 IC 必須接 VDD)

*All specs and applications shown above subject to change without prior notice.

(以上電路及規格僅供參考,本公司得逕行修正)



VDD CONTROL 64 PATTERN
VISION PERSISTENCE

電源控制
閃爍圖案 IC

LED FLASH	
M1173A / -1	

* M1173A

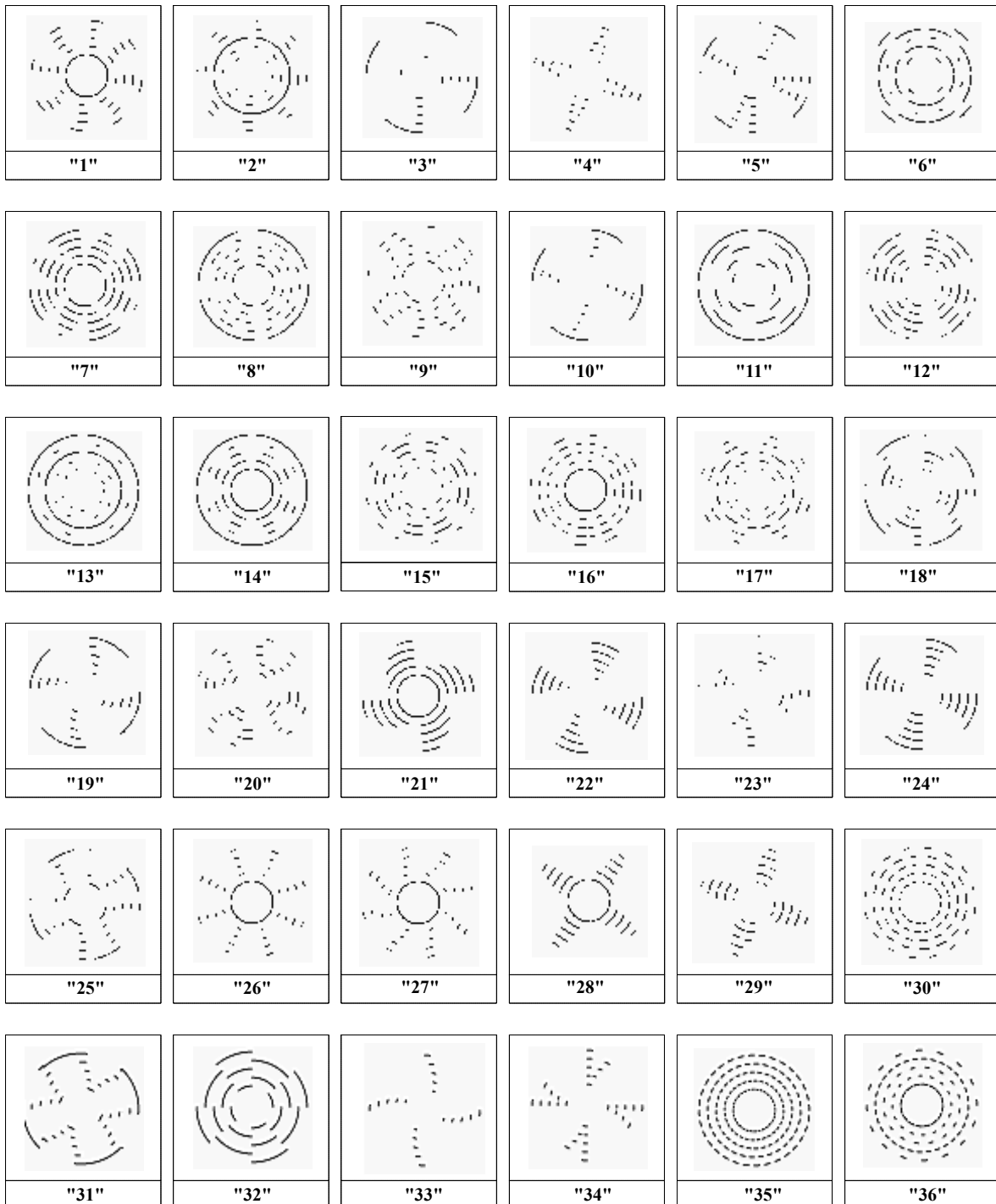



VDD CONTROL 64 PATTERN
VISION PERSISTENCE

電源控制
閃爍圖案 IC

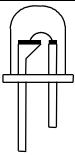
LED FLASH	
M1173A / -1	

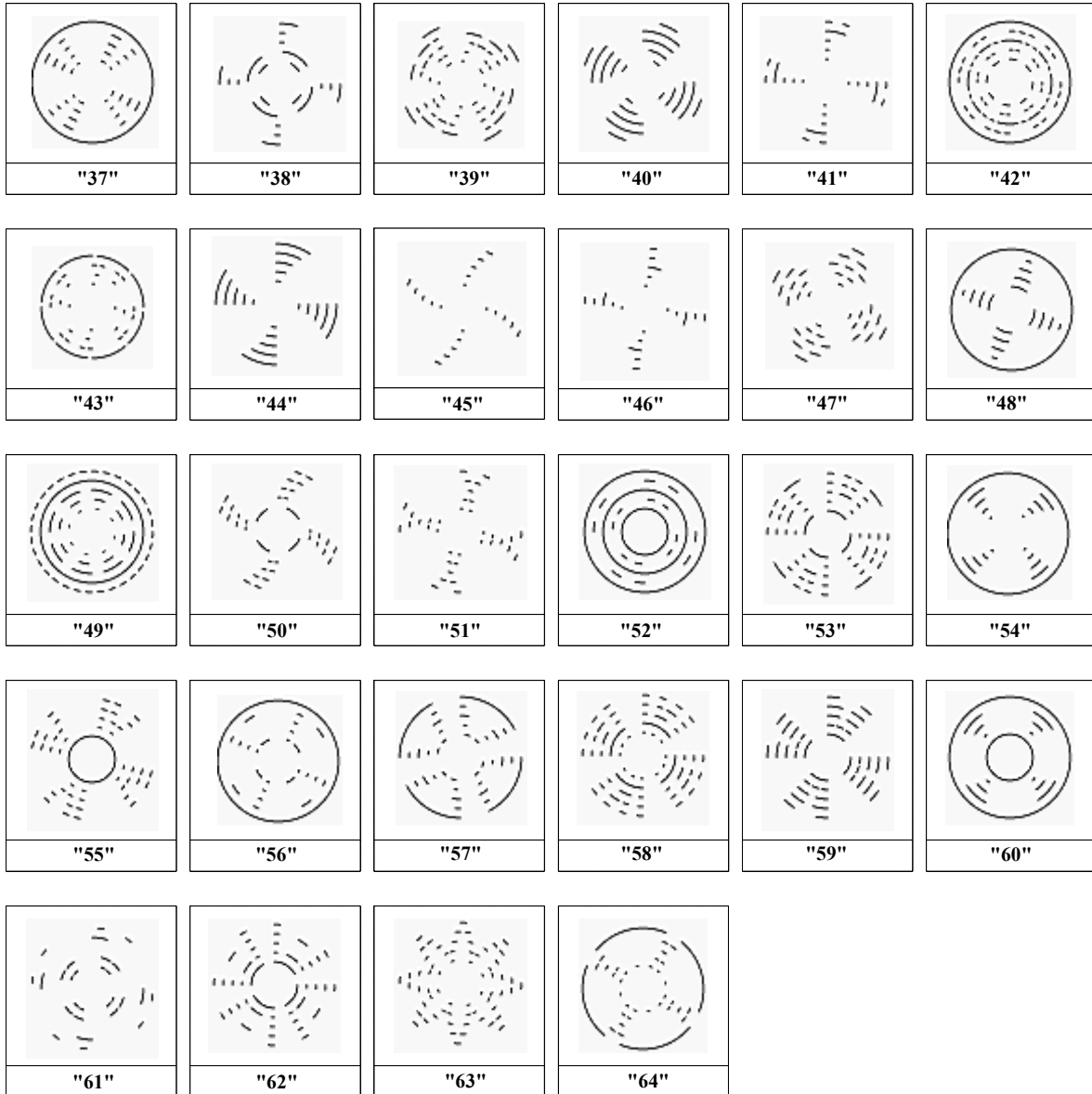



VDD CONTROL 64 PATTERN
VISION PERSISTENCE

電源控制
閃爍圖案 IC

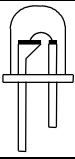
LED FLASH	
M1173A / -1	

* M1173A-1

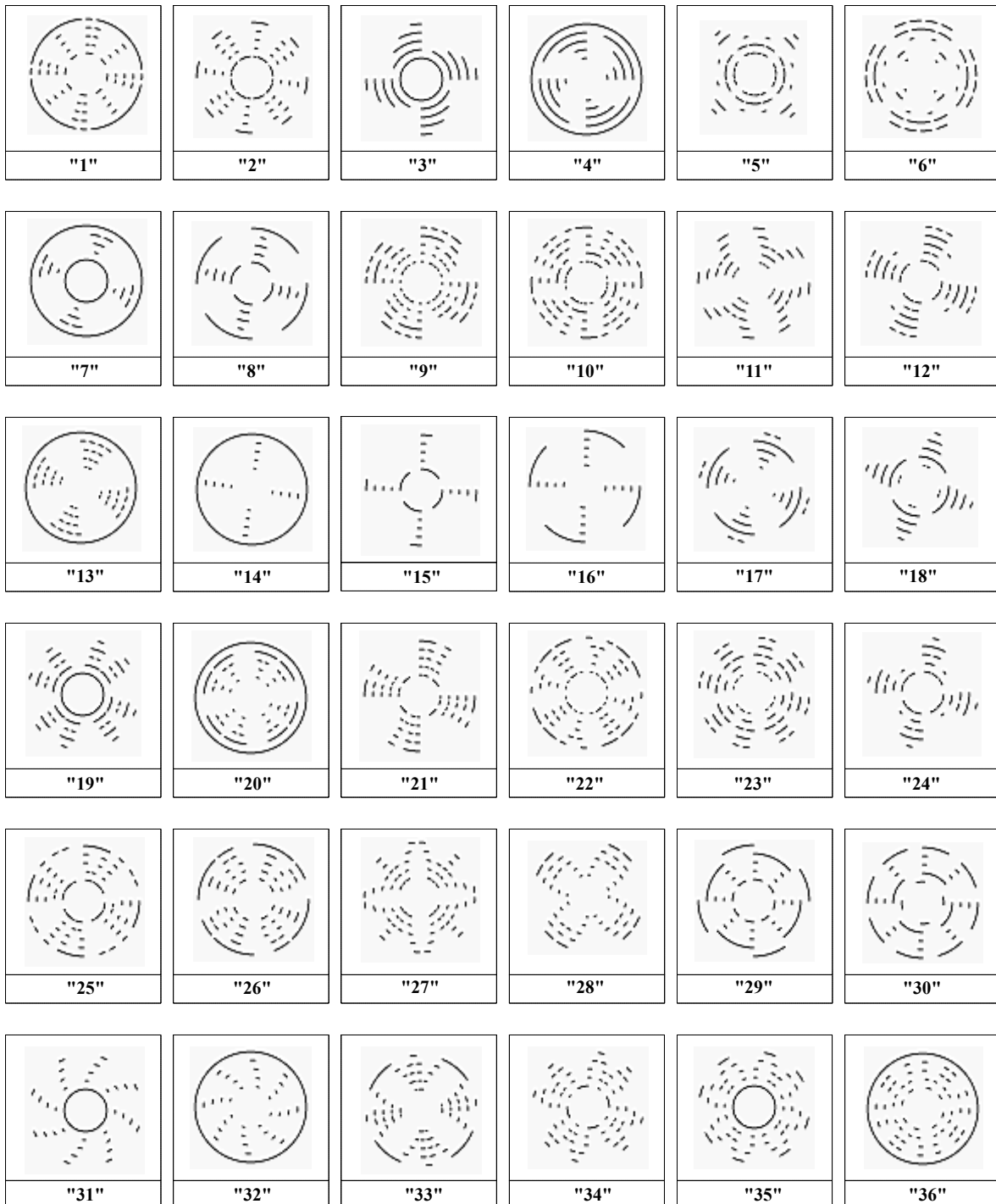



VDD CONTROL 64 PATTERN
VISION PERSISTENCE

電源控制
閃爍圖案 IC

LED FLASH	
M1173A / -1	

