

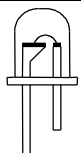

LED FLASH	
M1142A/M1143A	

BLINKING LED

LED 閃爍 IC

FEATURES 功能敘述

- Simple and easy to mount in LED lamp.
- Gold plating : suffix-G.

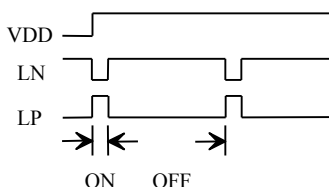

P/N	ON	OFF	LED	DUTY
M1142A-1	0.75"	3"	LP	1/5
M1143A-1	0.75"	3"	LN	1/5

APPLICATION 產品應用

- Blinking LED, Function indicator, Xmas decoration.

ELECTRICAL CHARACTERISTICS 電氣規格

( @V<sub>DD</sub>=3V unless otherwise specified )

Characteristics	Sym.	Min.	Typ.	Max.	Unit	REMARKS
工作電壓 Operating Voltage	V <sub>DD</sub>	2	3	3.5	V	
工作電流 Operating Current	I <sub>OP</sub>	—	0.1	0.5	mA	No load
靜態電流 Quiescent Current	I <sub>SB</sub>	—	—	—	μA	
推動電流 Driving Current	I <sub>OL</sub>	1	2	—	mA	@V <sub>DS</sub> =1V
振盪頻率 Oscillator Frequency	F <sub>OSC</sub>	—	131	—	KHz	±30% TOL.
工作溫度 Operating Temperature	Temp.	0	25	60	°C	

APPLICATION DIAGRAM 參考電路圖

(1) SOURCE TYPE

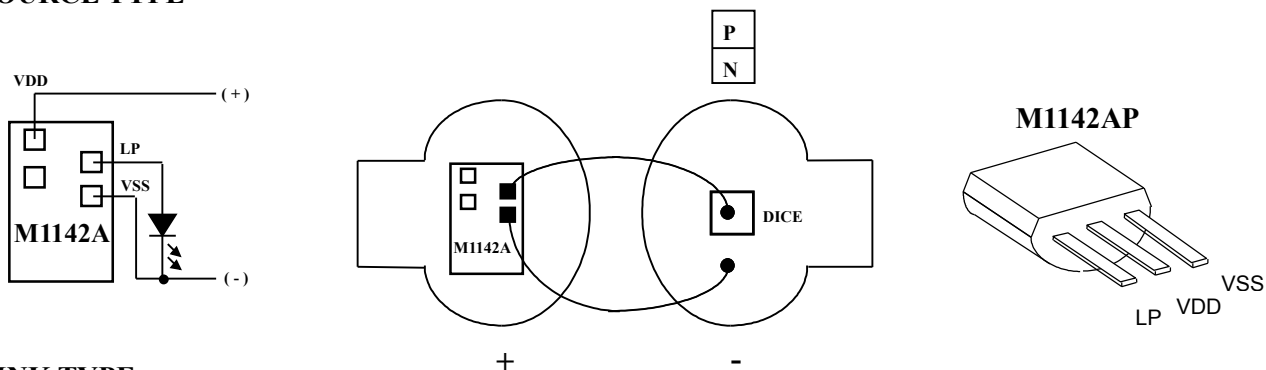

(2) SINK TYPE

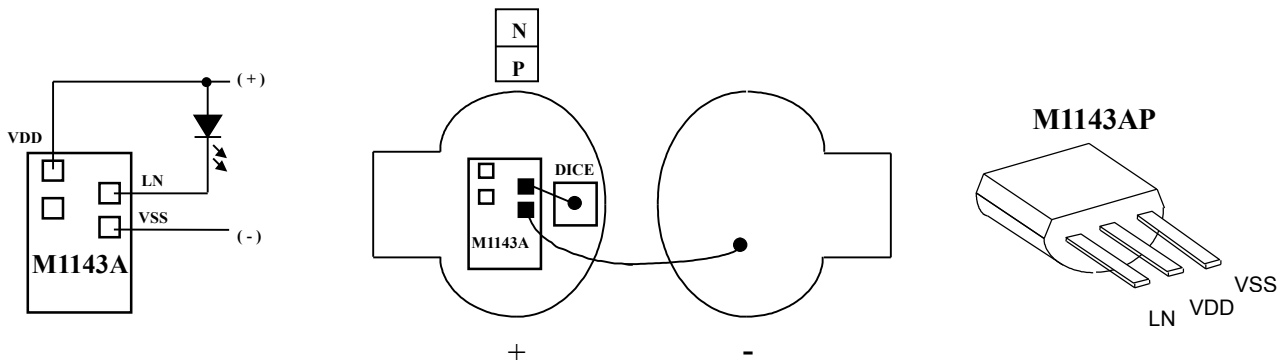

\* IC PAD ~ 100 x 100 μm<sup>2</sup>

\* IC CHIP ~ 0.78 x 0.56 mm<sup>2</sup>, substrate to VDD.

\* All specs and applications shown above subject to change without prior notice.

( 以上電路及規格僅供參考,本公司得逕行修正 )

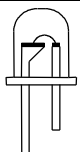

LED FLASH	
M1142A/M1143A	

BLINKING LED

LED 閃爍 IC

SOURCE TYPE

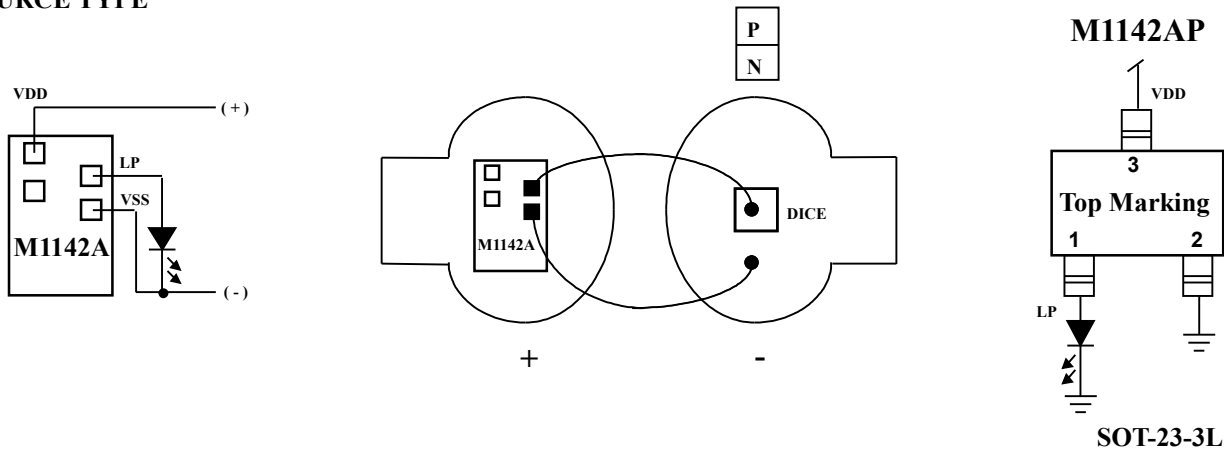

PAD ASSIGNMENT & POSITION

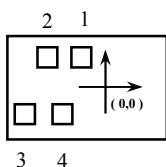

UNIT : um

No.	NAME	X	Y
1	VSS	33.1	152.2
2	LED	-149.2	152.2
3	VDD	-265	-152.2
4	TEST	-82.6	-152.2

\* CHIP SIZE ~ 0.78 x 0.56 mm<sup>2</sup>

\* IC substrate should be connected to VDD in PCB (PCB 上 IC 必須接 VDD)